

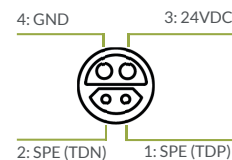

### Key Features

- Conversion between BASE-TX and BASE-T1
- 24VDC power feed
- Bundles data and power for reduced cabling
- Power and data infrastructure connectivity with standard M8 connectors

## Dimensional Drawing & Pinout

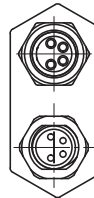
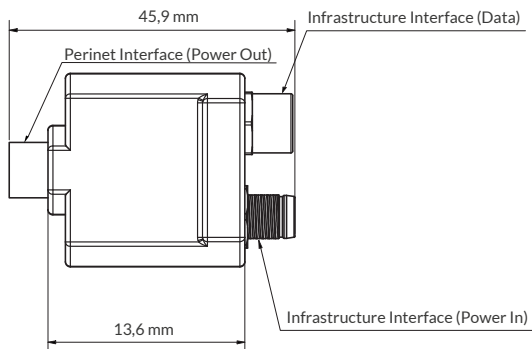
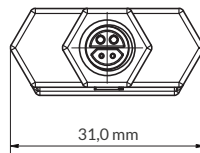
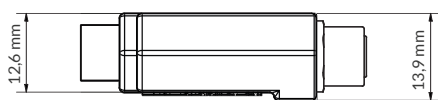

Perinet Interface (Power Out)  
M8 female (front view)

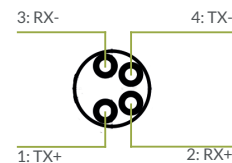

Infrastructure Interface (Data)  
M8 A-coded female (front view)

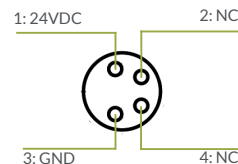

Infrastructure Interface (Power In)  
M8 A-coded male (front view)

This periSTART media converter is the interface between your existing infrastructure and the Perinet Seamless IoT Connectivity system. It converts between Fast Ethernet (BASE-TX) and Single Pair Ethernet (BASE-T1), thereby enabling seamless communication between the field level and your IT-system or data hub, and provides a 24VDC feed to attached sensors and actuators. periSTART bundles data and power supply and transmits both to the Perinet Seamless IoT Connectivity system via the 4-wire periLINE hybrid SPE cable.

### Area of application

periSTART Standard connects to your infrastructure via standard M8 connectors.

It is the starting point to your field-level sensor and actuator network to facilitate a wide variety of IoT and IIoT use cases.

Please note that periSTART is not designed for real-time or safety-critical applications.



## Technical Specifications

### Perinet Interface (Power Out)

Type	M8 female connector according to IEC 63171-6:2020 (style 6P-M8C without shielding)
------	--

Communication	100BASE-T1 Single Pair Ethernet (IEEE 802.3bw)
---------------	--

Power	24VDC output
-------	--------------

### Infrastructure Interface (Data)

Type	M8 A-coded female connector
------	-----------------------------

Communication	100BASE-TX Fast Ethernet (IEEE 802.3u)
---------------	--

### Infrastructure Interface (Power In)

Type	M8 A-coded male connector
------	---------------------------

Input Voltage	24VDC (+/-10%)
---------------	----------------

Consumption	Average 528mW (max. 2A throughput current)
-------------	--

### Housing

Material	Hotmelt
----------	---------

Protection Class	IP67
------------------	------

Temperature Range	-40°C...+70°C
-------------------	---------------

Electromagnetic Compatibility (EMC)	Immunity for industrial environments (EN 61000-6-2:2005, EN 61000-6-2:2005/AC:2005)
-------------------------------------	---

Emission standard for industrial environments (EN 61000-6-4:2007, EN 61000-6-4:2007/A1:2011)
--

Compliance	CE, RohS, WEEE
------------	----------------

**Note:** We reserve the right to make technical changes to the products and to the content of this document at any time without prior notification. Perinet GmbH does not accept any responsibility for possible errors or incompleteness in this document. We reserve all the rights to this document and the topics and illustrations contained within it. Copying, disclosure to third parties or use of its content - even partially - is forbidden without the prior written consent of Perinet GmbH.